

## Tapón 5 mm.

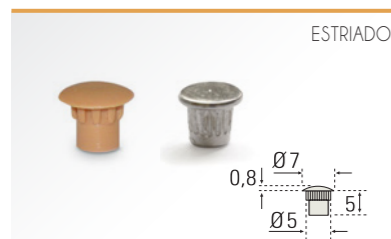

### Plástico

Blanco	Ref.	F21001
Roble	Ref.	F21002
Cerezo	Ref.	F21003
Haya	Ref.	F21004
Haya M	Ref.	F21005
Nogal	Ref.	F21006
Nogal 2	Ref.	F21007
Incoloro	Ref.	F21008
Aluminio	Ref.	F21009
RCórdoba	Ref.	F21011
Cerezo Barnizado	Ref.	F21012
Wengué	Ref.	F21015
<b>Zamak</b>	Ref.	<b>F21018</b>
Embalaje		150.000 Uds.

## Tapón 8 mm.

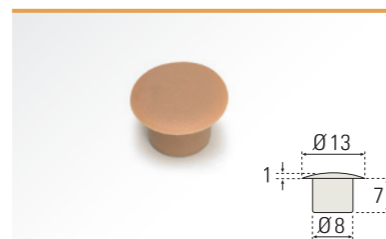

### Plástico

Blanco	Ref.	F21051
Roble	Ref.	F21052
Cerezo	Ref.	F21053
Haya	Ref.	F21054
Haya M	Ref.	F21055
Nogal	Ref.	F21056
Nogal 2	Ref.	F21057
Incoloro	Ref.	F21063
Aluminio	Ref.	F21058
RCórdoba	Ref.	F21061
Cerezo Barnizado	Ref.	F21059
Wengué	Ref.	F21062
<b>Zamak</b>		
Embalaje		40.000 Uds.

## Tapón 10 mm.

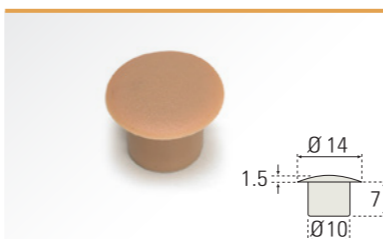

### Plástico

Blanco	Ref.	F21701
Roble	Ref.	F21702
Cerezo	Ref.	F21703
Haya	Ref.	F21704
Haya M	Ref.	F21705
Nogal	Ref.	F21706
Nogal 2	Ref.	F21707
Incoloro	Ref.	F21709
Aluminio	Ref.	F21708
RCórdoba	Ref.	F21713
Cerezo Barnizado		
Wengué		
<b>Zamak</b>		
Embalaje		25.000 Uds.

## Tapón 20 mm.

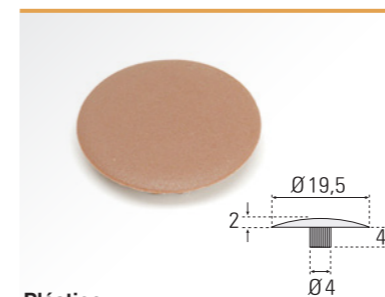

### Plástico

Blanco	Ref.	F21251
Roble	Ref.	F21252
Cerezo	Ref.	F21253
Haya	Ref.	F21254
Haya M	Ref.	F21255
Nogal	Ref.	F21256
Nogal 2	Ref.	F21257
Incoloro	Ref.	
Aluminio	Ref.	F21266
RCórdoba	Ref.	F21259
Wengué	Ref.	F21258
<b>Zamak</b>		
Embalaje		25.000 Uds.

## Tapón 25 mm.

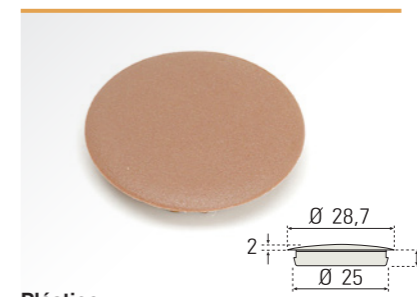

### Plástico

Blanco	Ref.	F21201
Roble	Ref.	F21202
Cerezo	Ref.	F21203
Haya	Ref.	F21204
Haya M	Ref.	F21205
Nogal	Ref.	F21206
Nogal 2	Ref.	F21207
Incoloro	Ref.	F21213
Aluminio	Ref.	F21209
RCórdoba	Ref.	F21210
Wengué	Ref.	F21211
<b>Zamak</b>		
Embalaje		8.000 Uds.

## Tapón 25 mm. Zamak

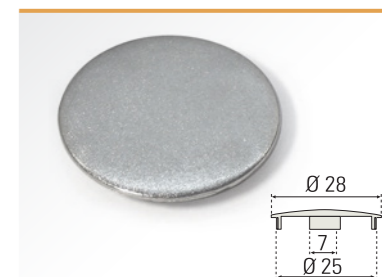

<b>Zamak</b>	Ref.	<b>F21230</b>
Embalaje		2.500 Uds. x Bolsa 5 Bolsas x Caja

## Tapón 13 mm.

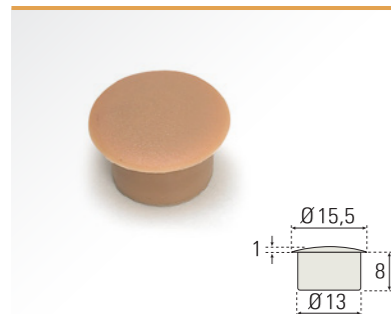

### Plástico

Blanco	Ref.	F21101
Roble	Ref.	F21102
Cerezo	Ref.	F21103
Haya	Ref.	F21104
Haya M	Ref.	F21105
Nogal	Ref.	F21106
Nogal 2	Ref.	F21107
Incoloro		
Aluminio	Ref.	F21108
RCórdoba		
Wengué		
<b>Zamak</b>		
Embalaje		17.000 Uds.

## Tapón 18 mm.

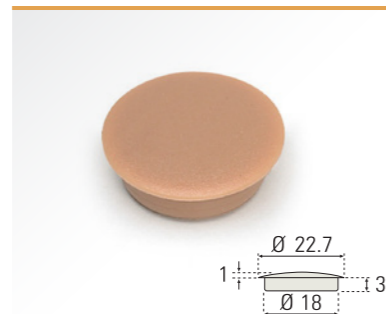

### Plástico

Blanco	Ref.	F21151
Roble	Ref.	F21152
Cerezo	Ref.	F21153
Haya	Ref.	F21154
Haya M	Ref.	F21155
Nogal	Ref.	F21156
Nogal 2	Ref.	F21157
Incoloro	Ref.	F21158
Aluminio	Ref.	F21161
RCórdoba	Ref.	F21162
Wengué	Ref.	F21159
<b>Zamak</b>		
Embalaje		14.000 Uds.

## Tapón 18 mm. Zamak



<b>Zamak</b>	Ref.	<b>F21180</b>
Embalaje		5.000 Uds. x Bolsa 10 Bolsas x Caja

## Tornillo ensamblaje

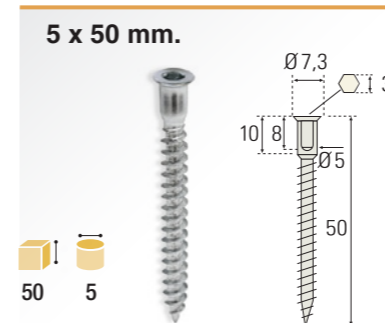

### Plástico

Blanco		
Roble		
Cerezo		
Haya		
Haya M		
Nogal		
Nogal 2		
Aluminio		
Incoloro		
Wengué		
Roble Córdoba		
<b>Zamak</b>	Ref.	<b>F23003</b>
Embalaje		3.500 Uds.

## Tapón tornillo

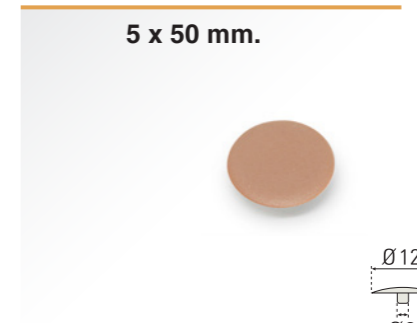

### Plástico

Blanco		F21021
Roble		F21022
Cerezo		F21023
Haya		F21024
Haya M		F21025
Nogal		F21026
Nogal 2		F21027
Aluminio		F21028
Incoloro		F21029
Wengué		F21030
Roble Córdoba		F21031
<b>Zamak</b>		
Embalaje		65.000 Uds.

## Llave allen 3 mm.



<b>Zamak</b>		<b>F21810</b>
Embalaje		700 Uds.



Blanco



Roble



Cerezo



Haya



Haya M.



Nogal



Nogal 2



Incoloro



Aluminio



R. Córdoba



Wengué



Zamak